

Pneufit® M PUSH-IN fittings, metric

- Port size: Ø 3, 4 and 6 mm O/D tube
- Miniature Pneufit® M an ultra compact alternative where space is at a premium.
- Releasable stainless-steel grab-ring to grip
- PA or PUR tube (85 or 95 durometer).
- Nickel plated brass components provide corrosion and contamination resistance and an extended life.
- Pre applied thread sealant on all taper threads and recessed captive O-ring on parallel threads provides optimum rapid sealing.



Technical features

<p>Medium: Compressed air Operating pressure: 10 bar (145 psi) max.</p> <p>Vacuum: 750 mmHg</p>	<p>Tube sizes: 3, 4, and 6 mm</p> <p>Thread sizes: M3, M5, M6, R1/8 and Rc1/8</p> <p>Tubing types: PA 11 or 12 PUR 85, 95 or 98 durometer</p>	<p>Ambient/Media temperature: -20°C ... +60°C (+32 ... +140°F)</p>	<p>Materials: Body: PBT Seals: NBR (VMQ free) u-packing and O-rings Threaded bodies: nickel plated brass Backing ring: POM Grab-ring: stainless steel Collar: nickel plated brass Thread sealant: Chemitech G-175L</p>
--	--	--	---

Method of assembly



1. Ensure that the end of the tube is cut square and is free from burrs.



2. Push the tube through the collet into the fitting.



3. Continue pushing the tube through the 'O'-ring until it bottoms on the tube stop then pull back.

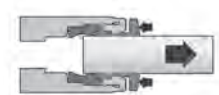

4. To disconnect push the tube into the fitting, hold down the collet and withdraw the tube.

Components

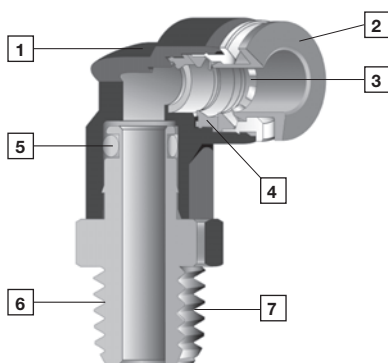

- 1 Impact resistant PBT body in grey
- 2 Release buttons are grey
- 3 Stainless steel grab ring with special design to retain softer tube and provide easy releasability.
- 4 Silicon free U-packing provides leak tight tube seal under side loading.
- 5 Stem seal provides leak tight 360° swivel connection.
- 6 Nickel plated brass threads
- 7 Pre-applied thread sealant on tapered threads and recessed captive O-ring on parallel threads.

Option selector

M0 ★★★★★★



Typical dimensions

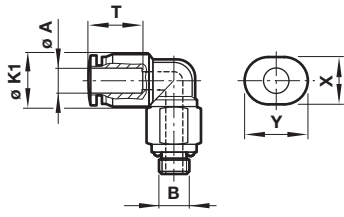

Ø A	Ø K1	T	X	Y
3	7,5	11,5	7	9
4	8,5	12	8	10,5
6	11	13	10	12,5

B	Recommended torque
M3	0,7 Nm
M5	1,5 Nm
M6	2,3 Nm
R1/8	7 Nm



Straight adaptors and connectors

<p>Straight union (equal) M0020</p>  <p>Page 3</p>	<p>Straight union (unequal) M0020</p>  <p>Page 3</p>	<p>Straight adaptor (external hex only) M0125/M0225</p>  <p>Page 3</p>	<p>Straight adaptor (internal hex only) M012A/M022A</p>  <p>Page 3</p>	<p>Straight adaptor M0126/M0226</p>  <p>Page 3</p>
--	---	---	--	---

Elbow adaptors and connectors

<p>Union elbow M0040</p>  <p>Page 3</p>	<p>90° Swivel elbow adaptor M0147/M0247</p>  <p>Page 3</p>	<p>Union tee M0060</p>  <p>Page 5</p>	<p>Swivel tee adaptor M0167/M0267</p>  <p>Page 5</p>	<p>Swivel side tee adaptor M0168/M0268</p>  <p>Page 5</p>
---	---	--	--	--

Y connectors

<p>Union Y (equal) M0082</p>  <p>Page 5</p>	<p>Union Y (unequal) M0082</p>  <p>Page 5</p>
---	--

Straight union M0020

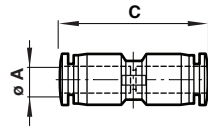

Equal

Ø A	C	Model
3	23,5	M00200300
4	26	M00200400
6	26,5	M00200600

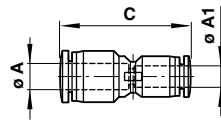

Unequal

Ø A	A1	C	Model
4	3	24	M00200403
6	3	24	M00200603
6	4	26,5	M00200604

Straight adaptor (external hex only) M0125, M0225

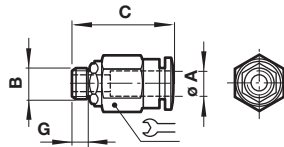

Ø A	B	C	G		Model
3	M3	17	4	7	M02250303
3	M5	17,5	4,5	8	M02250305
3	M6	18	5	8	M02250306
4	M3	17,5	4	8	M02250403
4	M5	18	4,5	8	M02250405
4	M6	19	5	8	M02250406
4	R1/8	19	6	12	M01250418
6	M5	19,5	4,5	10	M02250605
6	M6	20	5	10	M02250606
6	R1/8	19,5	8	12	M01250618

Straight adaptor (internal hex only) M012A, M022A

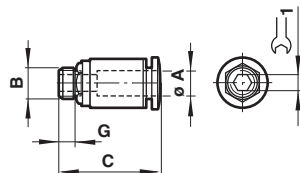

Ø A	B	C	G		Model
3	M3	17	4	1,5	M022A0303
3	M5	17,5	4,5	2	M022A0305
3	M6	18	5	2	M022A0306
4	M3	17,5	4	1,5	M022A0403
4	M5	19	4,5	2,5	M022A0405
4	M6	19	5	3	M022A0406
4	R1/8	17,5	8	3	M012A0418
6	M5	19,5	4,5	2,5	M022A0605
6	M6	20	5	3	M022A0606
6	R1/8	19,5	8	2,5	M012A0618

Straight adaptor (female thread) M0126, M0226

Dimensions in mm
Projection/First angle

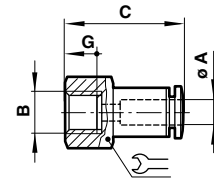

Ø A	B	C	G		Model
3	M3	17,5	4	8	M02260303
3	M5	19	6	8	M02260305
3	M6	19	6	8	M02260306
4	M3	18	4	8	M02260403
4	M5	19,5	6	8	M02260405
4	M6	19,5	6	8	M02260406
4	Rc1/8	23	8,5	12	M01260418
6	M5	21,5	6	10	M02260605
6	M6	21,5	6	10	M02260606
6	Rc1/8	25,5	8,5	12	M01260618

Union elbow M0040

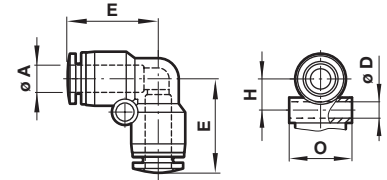

Ø A	Ø D	E	H	O	Model
3	3,2	13,5	5,5	7,5	M00400300
4	3,2	14,5	6	8,5	M00400400
6	3,2	16,5	7	10,5	M00400600

90° Swivel elbow adaptor M0147, M0247

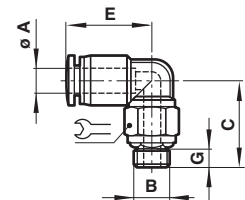

Ø A	B	C	E	G		Model
3	M3	15	13,5	3	8	M02470303
3	M5	15	13,5	4	8	M02470305
3	M6	16	13,5	4	8	M02470306
4	M3	15	14,5	3	8	M02470403
4	M5	16	14,5	4	8	M02470405
4	M6	16	14,5	4	8	M02470406
4	R1/8	16	14,5	8	10	M01470418
6	M5	17	15,5	3,5	8	M02470605
6	M6	17	15,5	4	8	M02470606
6	R1/8	17	15,5	8	10	M01470618

Union T M0060

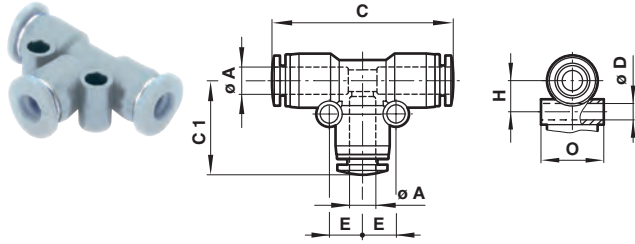

Ø A	C	C1	Ø D	E	H	O	Model
3	26,5	13,5	3,2	5,5	5,5	7,5	M00600300
4	28,5	14,5	3,2	6	6	8,5	M00600400
6	33	16,5	3,2	7	7	10,5	M00600600

Swivel side tee adaptor M0168, M0268

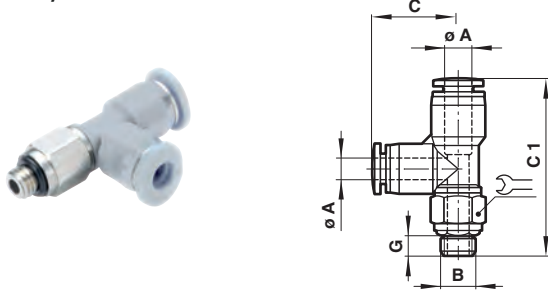

Ø A	B	C	C1	G	Symbol	Model
3	M3	13,5	29,5	3	8	M02680303
3	M5	13,5	30	4	8	M02680305
3	M6	13,5	30,5	4	8	M02680306
4	M3	14	30,5	3	8	M02680403
4	M5	14	31	3,5	8	M02680405
4	M6	14	31,5	4	8	M02680406
4	R1/8	14	31,5	6	14	M01680418
6	M5	16,5	33,5	3,5	8	M02680605
6	M6	16,5	34	4	8	M02680606
6	R1/8	16,5	33,5	6	14	M01680618

Swivel tee adaptor M0167, M0267

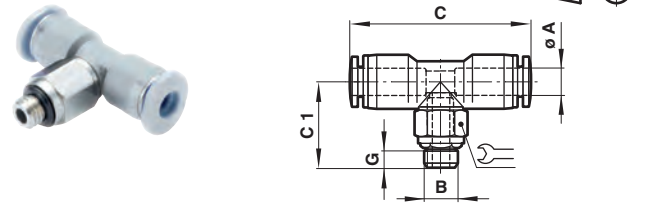

Ø A	B	C	C1	G	Symbol	Model
3	M3	25,5	16	3	8	M02670303
3	M5	29	17	4	8	M02670305
3	M6	27	17	4	8	M02670306
4	M3	28,5	16	3	8	M02670403
4	M5	28,5	17	3,5	8	M02670405
4	M6	29	17	4	8	M02670406
4	R1/8	29	18	6	14	M01670418
6	M5	31	17	3,5	8	M02670605
6	M6	31	17	4	8	M02670606
6	R1/8	31	18	6	14	M01670618

Union Y M0082

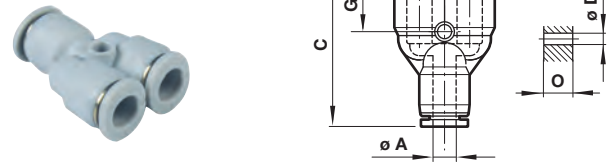

Equal

Ø A	C	D	H	L	O	Model
3	27	3,2	11	8	7,5	M00820300
4	28	3,2	11,5	9	8,5	M00820400
6	31	3,2	12	11,5	11	M00820600

Unequal

Ø A	Ø A1	C	D	G	L	O	Model
4	3	27,5	3,2	11	8	8,5	M00820403
6	3	28,5	3,2	11	8	11	M00820603
6	4	29	3,2	11,5	9	11	M00820604

Warning

These products are intended for use in industrial compressed air systems only. Do not use these products where pressures and temperatures can exceed those listed under

»Technical features/data«.

Before using these products with fluids other than those specified, for non-industrial applications, life-support systems or other applications not within published specifications, consult Norgren.

Through misuse, age, or malfunction, components used in fluid power systems can fail in various modes.

The system designer is warned to consider the failure modes of all component parts used in fluid power systems and to provide adequate safeguards to prevent personal injury or damage to equipment in the event of such failure.

System designers must provide a warning to end users in the system instructional manual if protection against a failure mode cannot be adequately provided.

System designers and end users are cautioned to review specific warnings found in instruction sheets packed and shipped with these products.